



LCD-S700 Pedal Assisted/Throttled Ebike Smart Computer User's Manual

For Model:

Cyrusher XF660-1000w, XT750, XF500-G660

Contents

Introduction:

1. Outside Drawing and Size Requirements.....	4
1.)Main materials and colors.....	5
2.)Appearance dimensions and installation dimensions (Unit:mm)	5
3.)External key graphics dimensions and installation dimensions (Unit:mm)	5
4.)Schematic diagram.....	6
5.) Physical installation schematic.....	7
2.Product Introduction and Function Overview.....	7
1.)The two-way communication protocol and external three-way button facilitate the operation for customers.....	7
2.)Speed display.....	7
3.)Kilometer/mile display.....	7
4.)Intelligent battery display.....	7
5.)Headlight control.....	7
6.)Backlight brightness 3 adjustment.....	7
7.)5 Gears control.....	8
8.)Mileage display.....	8
9.)Fault code prompt.....	8
10.)6KM power-assisted mode.....	8
11.)Parameters setting.....	8
3.Liquid crystal display content and description.....	8
1.)Battery Indicator.....	8
2.)Speed mode.....	9
3.)Speed value display.....	9
4.)6KM power-assisted display.....	9
5.)Gear display.....	9
6.)Headlight display.....	9
7.)Mileage Mode.....	9
8.)Riding Time.....	9
9.)Error code display.....	9
4.External key definition.....	9
5.Instructions for operating methods and functions.....	9
1.)Starting up shutdown.....	9
2.)Speed mode switching.....	10
3.)Mileage mode, riding time and error code switching.....	11
4.)Power gear selection.....	12
5.)Headlight switch.....	13
6.)6KM assistance pushing (Walking pattern).....	13
6.System parameter setting.....	14

1.)Backlight brightness.....	15
2.)Metric/Inch system.....	15
3.)The working voltage meter supported.....	16
4.)Sleep time.....	16
5.)Steering gear.....	17
6.)Wheel diameter selection.....	18
7.)Measured number of magnetic steels.....	18
8.)Speed adjustment.....	19
9.)Zero start and non-zero boot Settings.....	19
10.)Driver setting.....	20
11.)Power sensitivity setting.....	21
12.)Power start strength setting.....	21
13.)Booster disk type setting.....	22
14.)Controller limited value stream setting.....	23
15.)The controller undervoltage value display.....	23
16.)Accumulated mileage resetting.....	24
17.)Restore Factory Defaults.....	24
7.Meter specification parameter.....	25
8.Error code definition.....	25
9.Using Tips.....	26
10.Common questions and answers.....	27
11.Quality commitment and warranty scope.....	27
12.Version changes.....	27

Introduction

Dear users, for your correct use of LCD - S700 LCD display instrument, please read the user's manual and relevant notes carefully before using. We will help you to understand and familiarize the instrument's functions with the simplest language, including how to operate the instrument, how to set system parameters, how to achieve the optimal matching state of motor, controller and instrument and how to improve the electric control performance of electric motor. The contents of this manual contain the installation, operation, system parameter setting and proper use of the instrument, which can help you to solve the problems and doubts in actual use.

1. Outside Drawing and Size Requirements.

1.)Main materials and colors

The material of LCD-S700 instrument shell and external key are mainly ABS, liquid crystal clear window is Acrylic.

2.)Appearance dimensions and installation dimensions (Unit:mm)

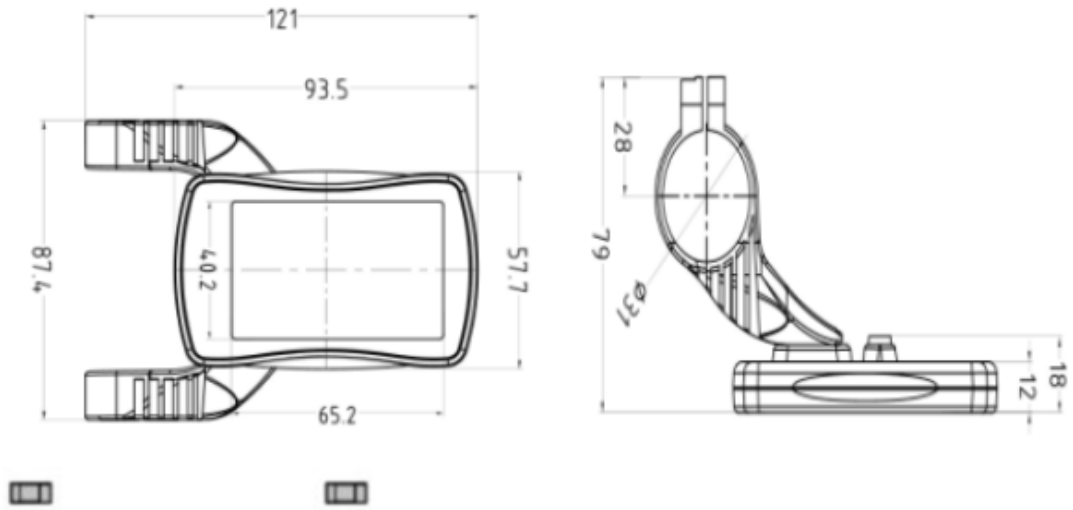

Screw 2.6*8

Screw 4*16



3.) External key graphics dimensions and installation dimensions (Unit:mm)



Screw 2*8

Screw 4*16

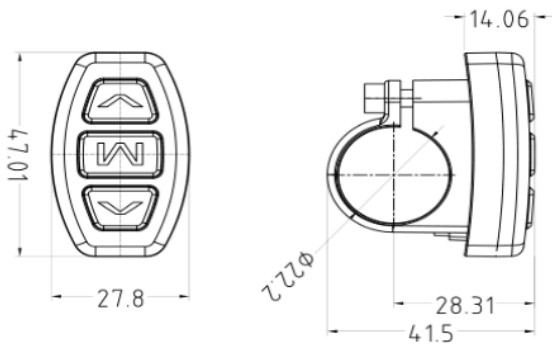

4.) Schematic diagram

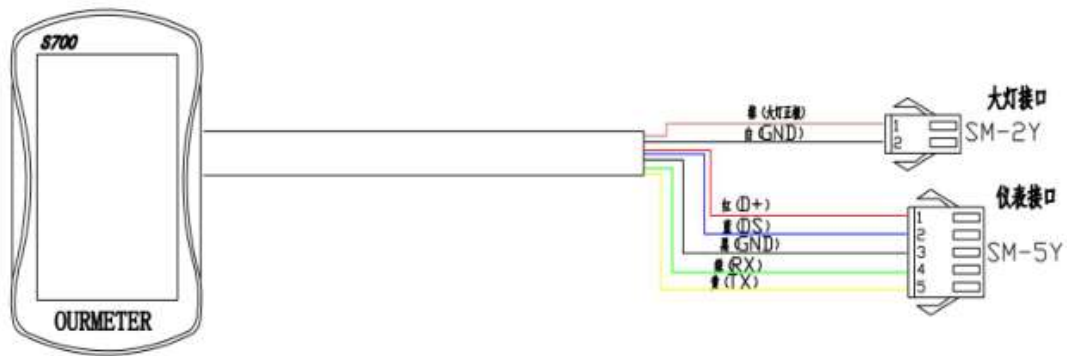

Red line: VCC

Blue line: Electric lock DS

Black line: GND

Green line: Data receiving line RX

Yellow line: Data sending line TX

Brown line: Headlight DD

White line: Headlight GND

Note: Specific wiring methods and line colors are customized according to customer requirements.

5.) Physical installation schematic

Fix the instrument LCD display part and external key to the electric vehicle and adjust the appropriate angles. Connect the instrumentation plug-in to the controller to the application plug-in, in the case of bike without power. Turn on the power, the electric bike and the instrument enter a normal operation condition, thus the instrument installation has been completed.



2. Product Introduction and Function Overview

- 1.) The two-way communication protocol and external three-way button facilitate the operation for customers
- 2.) Speed display: Including real-time speed, MAX SPEED, AVG SPEED.
- 3.) Kilometer/mile display: setting the kilometers(K/h) and miles(Mph) according to customers' habits.

- 4.) Intelligent battery display: display the battery's current power
- 5.) Headlight control: control the opening and closing of headlights through external keys
- 6.) Backlight brightness three adjustment: set backlighting according to customers' using habits, 1 grade means-darkest, 3 grade means-lightest.
- 7.) Five gears control: according to customers' requirements, you can choose the assisted gears 0-5 by the outer button, and 0 means neutral gear, no assistance (The default is 5 gear).
- 8.) Mileage display: the cumulative mileage can be displayed is 0D0, single mileage TRIP, riding time.
- 9.) Fault code prompt: the details is in the error code definitions and schedule 1
- 10.) 6KM power-assisted mode: it displays cruising WALK in the 6KM power-assisted mode
- 11.) Parameters setting: all parameters can be set by setting the interface, including gear, wheel.

3. Liquid crystal display content and description

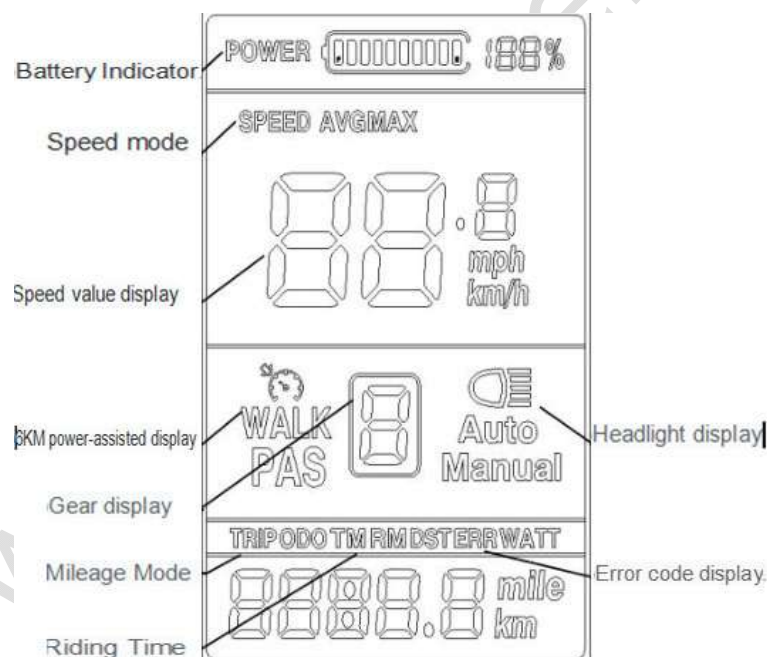

- 1.) Battery Indicator: 10 segments energy indicators, can set the voltage values of each segment according to customers' requirements.
- 2.) Speed mode: AVG SPEED, MAX SPEED, SPEED.
- 3.) Speed value display: Km/h, kilometres per hour, MPH miles per hour
- 4.) 6KM power-assisted display: it displays cruising WALK in the 6KM power-assisted mode
- 5.) Gear display: display the current assisted gear, 0-5, and 0 means neutral gear, no assistance.
- 6.) Headlight display: it displays when the headlight and backlight is on.

- 7.)Mileage Mode :including the single mileage TRIP and the cumulative mileage OD0,
 8.)Riding Time: displays the riding times
 9.)Error code display: ERRO and error code are displayed when the fault is detected

4.External key definition.

LCD-S700 adopts the LCD part and external three - to - button separation in the form of design, the communication is connected by the bottom lead.

There are three keys, using the key  replaces “UP”,  replaces

“MORE”,  replaces “DOWN”.

5.Instructions for operating methods and functions

1.)Starting up shutdown

Long-press the MODE button for 3 seconds when the instrument is off, the instrument fully shows and starts working, turn on the controller power; In boot state , long press

the button  for 3 seconds, the cyclocomputer be power off and close the controller power supply. If there is no riding or not any operations to the instrument in 10 minutes(set time by the user), the instrument will power off automatically. In the shutdown state, the power consumption of the instrument and the controller is 0.

The instrument boot display interface is as the image 1 shown.



Image 1

2) Speed Mode Switch



Long press the button  and  to change the display information of speed, show the real-time speed → the max speed → the average speed cyclically. Display interface of speed mode、riding time are as the image 2,3,4 shown.



Image 2



Image 3



Image 4

3) Mileage Mode、Riding Time、Error Code switch



Shortly press the button to switch the display of Mileage Mode、Riding Time、Error Code, show the Trip → ODO → Riding Time → ERR cyclically.

The display interface of switch mode are as the Image 5,6,7,8 shown.



Trip

Image 5



ODO

Image 6



Riding Time

Image 7



ERR

Image 8

4) Assistance Stall Chose





Shortly press the button  and  to switch the assistance stalls, change the motor assistance power, min stall 1, max stall 5. It is stall 1 by default in boot state, stall 0 is neutral, which can be seen as the image 9,10 shown.



Image 9



Image 10

5) Headlight Switch



Long press the button  for 3 seconds to open the bike light. Long press the button  for 3 seconds again to close the bike light. The headlight display interface are as the image 11,12 shown.



Image 11



Image 12

6) 6KM Assistant Drive (walk mode)

Long press the button  for 3 seconds when in bike is in still state, then the ebike begin assistant drive state, speed presentation is according to the external conditions (Showing





Figure is 4.5~7.5km/h), showing the symbol of WALK. Release the button  (or long press the button  for 3 seconds or shortly press the button ) , the ebike would exit WALK mode. There are two ways of exiting WALK mode, Long press and shortly press. The specific using method will be according to the customer's request. As the Image 13







Image 13

shows.

6. System Parameter Settings

In the boot state, long press the button  and , the system enters parameter setting state(image 14). Under this state, setting the cyclocomputer,

then long press the button  and  again to exit the setting state or No Operation(10s) and to exit setting state automatically. In

the parameter setting state, shortly press the button  /  to

adjust the figure of parameter setting, press the button  to switch setting item and save the parameter figure of the last item.

1) **Back Brightness:** Showing P01, shortly press the button



to show 1-3, 1 is the darkest backlight, 3 is the brightest. 2 is the default state, as the image 14 shows.



Image 14

2) **Metric/Imperial :** showing P02, shortly press the button



to switch the display of km/h or mph to set metric/imperial, the default state is km/h, as the image 15,16

shows.



Image 15

km/h display



Image 16

mph display

3) Cyclocomputer Support Voltage: showing P03, shortly press the



button, shows 24~28, each up step is 12, the default is 36V, as the image 17 shows.



Image 17

Working Voltage Display

4) Sleep Time: showing P04, shortly press the button



, and shows 0~60, which indicates the time of

automatic shutdown when the bike is in still state or there is no operation. 0 presents “won’t automatic shutdown”. The default sleep time are 5 minutes, as the image 18 shows.



Image 18

5) **Assistance Stall:** showing P05, shortly press the button



and it displays 0, 1, 2.

0: the assistant stall is 3-stall mode, which are stall 1, 2, 3;

1: the assistant stall is 5-stall mode, which are stall 1, 2, 3, 4, 5.

2: the assistant stall is 9-stall mode, which are stall 1, 2, 3, 4, 5, 6, 7, 8, 9.

When the assistant stall is 1, there are 5 stall modes on the operation interface, as the image 19, 20 shows.



Assistant Stall Display

Image 19



Mode of Stall 5

Image 20

6) **Wheel Diameter Choose:** showing P06, shortly press the button



, switch to corresponding wheel diameter, the unit is inch, accuracy: 0.1, as the image 21 shows.



Wheel Diameter Display

Image 21

7) **Number of Speed Magnet:** showing P07, shortly press the button



to switch the display range 1-100, as the image 22 shows.



图 22

Shows the number of measured magnetic steel



8) Speed adjustment: display P08 short press

key /



key to switch display The speed limit range 0 ~ 100KM/H, 100 indicates the speed limit, as shown in figure 23



图 23

Display speed limit

9) Zero boot, non-zero boot setting: display P09, short



press key/ key to switch display 0, 1. 0: zero start, 1: non-zero start, as shown in figure 24



图 24

Display startup mode



10) Drive mode setting: display P10, short press

key/



key to switch display 0, 1, 2, as shown in figure 25

0: power driver (which determines how much power the output is through the power of the help gear, and then turns invalid);

1: electric drive (by turning the driver, the gear is invalid at this time);

2: power drive and electric drive coexist simultaneously (electrically driven zero-start state is invalid).





11) Support sensitivity setting : display P11, short press



key/

key to switch display 1~24. as shown in figure 26



图 26

Display the support sensitivity mode

12) Power start strength setting: display P12, short press



key/ key to switch display range from 0 to 5, as shown in figure 27.



图 27

Display the power start strength mode



13) Booster disk type setting, display P13, short press



key/ key to switch display 5,8,12 disk type, as shown in figure 28



图 28

Display the booster disk type setting mode



14) Controller limit flow setting, display P14 short press



key/ key to switch display range from 1~20A, as shown in figure 29.



图 29

Display the controller limit flow mode press

15) The controller undervoltage value display, display P15, display the controller undervoltage value, shown as figure 30



图 30

display

the controller undervoltage value mode

16) The cumulative mileage is zero: display P16, The speed position shows the



current cumulative mileage, long key(5s), when the speed shows 0, the cumulative mileage is zero. shown as figure 31, 32.



图 31



图 32

display0000
the cumulative mileage is zero



17) restore factory settings: display P17, long key(5s), when the speed shows SSSS, it means restore factory settings(except cumulative mileage), shown as figure 33.



图 33

display SSSS

7 Instrument specification parameter

- 1) 24V, 36V, 48V power supply
- 2) Rated working current 10mA
- 3) Maximum working current of meter 30mA
- 4) Shutdown leakage current is less than 1uA
- 5) Supply controller side working current 50mA
- 6) Temperature: - 18 ~ 65 °C
- 7) Storage temperature: - 30 ~ 80 °C

vjh

8 Error code definition

S700 can provide warning for the vehicle fault, in the LCD shows the ERROR icon when a failure is detected, the position ERROR code displayed ERROR code n, n = 0 ~ 11 shows ERROR, ERROR code comparison table 1 table as shown below

Status code (decimalism)	State	Process mode
0	normal	
6	Battery under voltage	Battery charge
7	Motor fault	Check whether the power line is loose
8	Handle fault	Check the links, if it is normal, then replace the handle
9	Controller fault	Check the links
10	Reception fault	Check the links of the instrument cable
11	Communication fault	Check the links of the instrument cable

Table 1

9 matters needing attention

In use, the time interval between starting and shutdown should not be less than 3 seconds, and do not press the MODE key when it is turned off

Pay attention to safe driving in use and avoid instrument crashing. Try not to use it in harsh conditions, such as heavy rain, heavy snow, and exposure. Try to avoid the use of battery under voltage and avoid damage to electric car batteries.

When the temperature is under 10°C, the screen will turn dark with the reduce of the temperature.

10 Frequently questions and answers

question: why it can not be started?

Answer: checking whether the wire harness of the instrument is in good contact with the controller.

question: How should the fault code be handled?

Answer: coming to the ebike agent for maintenance.

11 Quality commitment and warranty scope

After the instrument is out of the factory, the shell being scratched or broken is not repair. Lead line cuts, fracture is not repaired; Loss of circuit function, guarantee period: within 12 months since the instrument out of the factory.

12 Version changes

This instrument specification is the universal version for S700, a part of the instrument is different from this specification, both are based on the actual version.